

# BIANCO NXT

## pumps

### Cast Iron Peripheral Turbine

PTF37M - 802788

PTF60M - 802790



# 1. Introduction

Congratulations on your purchase of a **BIANCO NXT PTF** pump.

Peripheral Turbine pumps use a floating turbine style impeller with close tolerances between pump faces to move clean water economically with good pressure at low flow rates.

Unlike other centrifugal pumps, Peripheral Turbine pumps can transport fluids with a relatively high gas content. Even severe vapour bubble formation will not lead to flow cut-off or have a major impact on the pump's smooth running.

Suitable for pumping uncontaminated liquids in applications where low flow rates have to be pumped at high pressure.





Ideal for small domestic pressure boosting systems or industrial applications such as boiler feed systems, cooling, circulation or as pumps for the chemical industry.

# 2. Key Features

- Compact, simple design
- Close coupled 240V single phase TEFC motor with in-built auto reset thermal overload
- Robust and reliable
- Cast iron housing with cathaphoresis corrosion resistant coating and stainless steel impeller
- High quality mechanical shaft seal and high quality bearings
- Maximum liquid temp 40 degrees

PTF peripheral turbine pumps are best suited to 'flooded suction' type applications as they lack the ability to self-prime.









# 3. Symbols used in this manual

	Warning - Electrical safety
	Warning – Potential consequences of use outside of intended application(s). Includes environmental condition warnings.
	Mandatory warning
	Warning to disconnect power
	Read carefully

## 4. Contents

1. Introduction .....	2
2. Key Features.....	2
3. Symbols used in this manual .....	2
4. Contents.....	3
5. Warnings .....	3
6. Technical Specifications .....	4
7. Electrical Connections.....	4
8. General installation notes .....	5
9. Standards and Approvals.....	6
10. Warranties – Terms and Conditions.....	7
11. Trouble Shooting Guide .....	8

## 5. Warnings

	Read the manual carefully before starting and retain for future reference.
	Prior to starting installation or any maintenance the pump must be disconnected from the power supply and pressure relieved from the system including controller, pump and associated pipework.
	Any changes or modification to the wiring must be carried out by suitably qualified personnel.
	A qualified electrician should correctly size and install circuit breakers to protect the power supply. The fitment of additional surge protection is recommended.
	Never open the controller cover or pump terminal box cover while the pump is connected to electrical supply.
	This appliance is not intended for use by persons (including children) with reduced physical, sensory or mental capabilities, or lack of experience and knowledge, unless they have been given supervision or instruction concerning use of the appliance by a person responsible for their safety. Children should be supervised to ensure that they do not play with the appliance.
	To avoid excessive thermal shock to the motor the pump should not start more than 20 times in any one hour period.
	Ensure that the installation will comply with all applicable local regulations.

## 6. Technical Specifications

	Bia PTF37M 802788	Bia PTF60M 802790
Rated Voltage	230v (-6%, +10%) 1 PH 50 Hz	
P2 (Shaft power)	0.37kW	0.6kW
Current	2.5 amps	4.5 amps
Capacitor	8 uF 450V	16 uF 450V
Motor Type	Asynchronous TEFC with inbuilt thermal overload	
Motor duty	Continuous	
Insulation Class	F Class	
Ingress protection	IP44	
Max Head	46m	58m
Max Flow	36 l/min	58 l/min
Max operating pressure	6 bar	
Maximum water temp	40 deg C	
Maximum ambient temp	40 deg C	
Pump Body	Cast iron with corrosion resistant coating	
Impeller	Zinc free brass	
Mechanical Seal	Carbon/Ceramic/Nitrile	
O-rings	Nitrile	
Power cable	2m H05 Cable with AS/NZ 3112 (Type 1) 3 pin male power plug	
Inlet / Outlet	1" BSPF / 1" BSPF	
Dimensions mm	283 L x 174 H x 158 W	315 L x 210 H x 190 W
Weight	5.5kg	9kg

## 7. Electrical Connections



Always use an electrical outlet that is protected by Residual Current Device (RCD) Safety Switch with a trip current of 30mA or less. A Safety switch is required by Australian/New Zealand Standard AU/NZS 60335.1-2011.

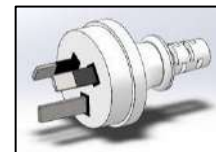

The pump is supplied with a 10 amp rated lead and AS/NZ 3112 (Type 1) 3 pin male power plug for connecting to mains power.



Exercise care with the power cord.  
Route the cord carefully to avoid potential snagging or chafing hazards.  
Never lift the pump by the power cord or disconnect from the power supply by pulling the cord.

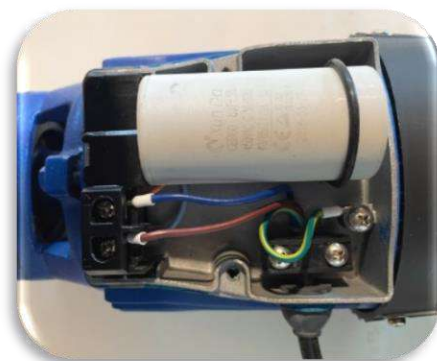

## 8. General installation notes

Following the basics will ensure your **BIANCO NXT PTF** will perform reliably

- Install the pump on a firm base as close to your water source as practical and close to a suitable power supply.
- Avoid the use of extension cords as they can result in voltage drop. If an extension cord must be used ensure it is correctly rated.
- Protect the pump and controller from rain and moisture and minimise exposure to extremes of heat and cold. Operating range 2°C - 40°C.
- Install the pump in a weather- proof, free draining, well vented enclosure to protect it from the extremes of temperature, moisture, flooding, chemicals, vermin, insects, dust etc.



The intake suction piping is the most critical part of the installation. Errors or air leaks will cause significant issues for performance and pump reliability.



### Reminders of best practice:

#### Inlet pipe

The inlet pipe must be the same size or larger than the inlet port size

As short and straight as practical

At least 150mm of straight pipe into the inlet (avoid bends directly on the inlet)

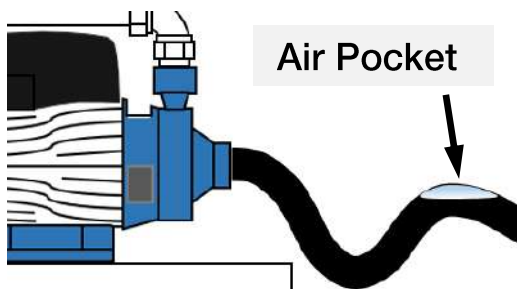
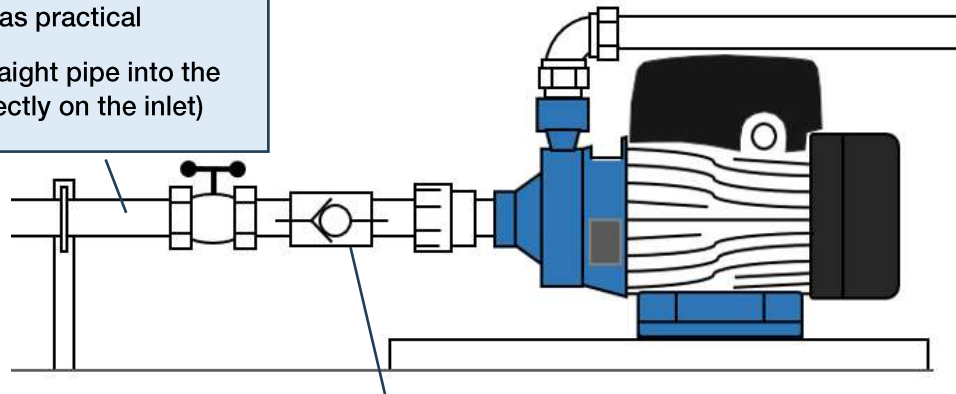

#### Inlet pipe

Fit a non-return valve on the inlet piping

An isolating valve on the inlet is recommended

Unions allow for easy connection/disconnection

Avoid piping which may result in air pockets

The pump and delivery line **MUST** be manually primed (filled) before the pump is started for the first time to ensure the mechanical seal is well lubricated. Dry operation causes irreparable damage to the mechanical seal.



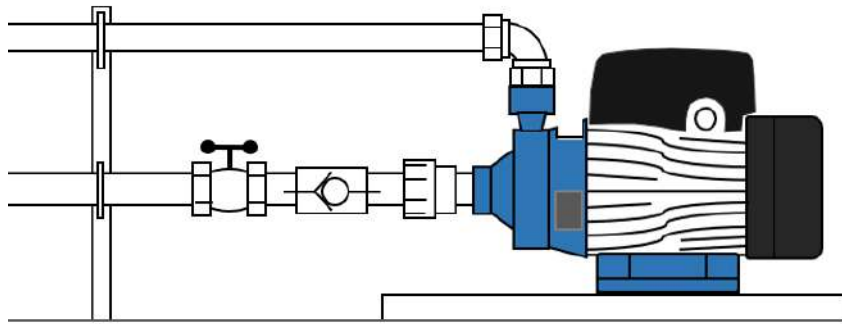

**Never start a pump until the pump chamber is filled with water.**

Avoid strain on the pump casing by supporting your pipework.



Mount the pump on a firm base in a dry, free draining area  
Protect the pump from weather, dust, insects and extremes of temperature

## 9. Standards and Approvals

	<p><b>SAA Approvals</b> is accredited by the Joint Accreditation Service of Australia and New Zealand (JAS-ANZ) as a third party certification body to issue of Certificates of Approval for declared and non-declared electrical equipment that has proven to comply with the safety requirements of the applicable Australian Standard.</p>
	<p>Pumps that carry the <b>AS/NZS4020 Drinking Water Approval</b> demonstrate compliance with requirements of Australia &amp; New Zealand Standards of products that come into contact with water intended for human consumption. This approval also ensures that the water coming from the pump will not be contaminated by toxic materials or metals. It also means the water will not support the growth of micro-organisms and will not cause a change in taste or appearance.</p>
	<p><b>CE marking</b> is a certification mark that indicates conformity with health, safety and environment. The CE marketing represents a manufacturer's declaration that products comply with the EU's New Approach Directives. These directives not only apply to products within the EU but also for products that are manufactured in or designed to be sold in the EEA.</p>

## 10. Warranties – Terms and Conditions

This warranty is given in addition to the consumer guarantees found within the Australian Competition and Consumer Act 2010 (Cth) for goods purchased in Australia and the Consumer Guarantees Act 1993 NZ for goods purchased in New Zealand:



1) White International Pty Ltd / White International NZ Ltd (White International) warrant that all products distributed are free from defects in workmanship and materials, for their provided warranty period as indicated on the top or opposite side of this document. Subject to the conditions of the warranty, White International will repair any defective products free of charge at the premises of our authorised service agents throughout Australia and New Zealand if a defect in the product appears during the warranty period. If you believe that you have purchased a defective product and wish to make a claim under this warranty, contact us on our Sales Hotline on 1300 783 601, or send your claim to our postal address or fax line below and we will advise you as to how next to proceed. You will be required to supply a copy of your proof of purchase to make a claim under this warranty.

2) This warranty excludes transportation costs to and from White International or its appointed service agents and excludes defects due to non-compliance with installation instructions, neglect or misuse, inadequate protection against the elements, low voltage or use or operation for purposes other than those for which they were designed. For further information regarding the suitability of your intended application contact us on our Sales Hotline on 1300 783 601. If you make an invalid claim under this warranty, the original product will be sent back to you unrepai red.

3) This warranty refers only to products sold after the 1st January 2012, and is not transferable to another product type and only applies to the original owner, purchaser or end user, and is in addition to the consumer guarantees found within the Competition and Consumer Act 2010 (Cth) for goods purchased in Australia and the Consumer Guarantees Act 1993 (NZ) for goods purchased in New Zealand.

4) Our goods come with guarantees that cannot be excluded under the Australian Consumer Law. You are entitled to a replacement or refund for a major failure and for compensation for any other reasonably foreseeable loss or damage. You are also entitled to have the goods repaired or replaced if the goods fail to be of acceptable quality and the failure does not amount to a major failure. 2 YEAR WARRANTY

5) To the fullest extent permitted by law, White International excludes its liability for all other conditions or warranties which would or might otherwise be implied at law. To the fullest extent permitted by law, White International's liability under this warranty and any other conditions, guarantees or warranties at law that cannot be excluded, including those in the Competition and Consumer Act 2010 (Cth), is expressly limited to: (a) in the case of products, the replacement of the product or the supply of equivalent product, the payment of the cost of replacing the product or of acquiring an equivalent product or the repair of the product or payment of the cost of having the product repaired, is at the discretion of White International or a 3rd party tribunal elected under the Competition and Consumer Act 2010 (Cth) for goods purchased in Australia and the Consumer Guarantees Act 1993 (NZ) for goods purchased in New Zealand; and

6) To the fullest extent permitted by law, this warranty supersedes all other warranties attached to the product or its packaging.

7) In the case of services, supplying the services again or the payment of the cost of having the services supplied again, is at the discretion of White International or a 3rd party tribunal elected under the Competition and Consumer Act 2010 (Cth) for goods purchased in Australia and the Consumer Guarantees Act 1993 (NZ) for goods purchased in New Zealand. 8) Our warranty commences from the date of purchase of the above mentioned pumps. Proof of purchase is required before consideration under warranty is given.

*Record your date of purchase in the space below and retain this copy for your records.*

**Date of Purchase** .....**Model Purchased** .....

## 11. Trouble Shooting Guide

	POSSIBLE CAUSE	POTENTIAL SOLUTIONS
The pump won't start and makes no noise	<ol style="list-style-type: none"> <li>1. No electricity</li> <li>2. Fuses or RCD tripped</li> <li>3. Internal motor fault</li> </ol>	<ol style="list-style-type: none"> <li>1. Check the power supply.</li> <li>2. Fuses or RCD tripped may indicate more serious problems</li> <li>3. Contact an expert to check the motor</li> </ol>
The pump doesn't start but makes a noise	<ol style="list-style-type: none"> <li>1. Motor not free to turn i.e. internal jamming</li> <li>2. Faulty capacitor</li> </ol>	<ol style="list-style-type: none"> <li>1. Check whether pump can rotate freely</li> <li>2. Contact an expert to check/replace capacitor</li> </ol>
The pump runs but there is no flow or only poor flow	<ol style="list-style-type: none"> <li>1. Valves closed</li> <li>2. Air entering suction line (loss of prime)</li> <li>3. The water level may be too low</li> <li>4. Pump may be worn or damaged</li> <li>5. Blockages in the pump, suction or discharge lines</li> <li>6. In-line filters blocked (if fitted)</li> <li>7. The piping may be too long or too small</li> </ol>	<ol style="list-style-type: none"> <li>1. Check suction and discharge isolating valves</li> <li>2. Check for leaks and ensure all joins or fittings are sealed</li> <li>3. Check water availability</li> <li>4. Contact your service agent for repair</li> <li>5. Contact your service agent for repair</li> <li>6. Clean any filters/strainers in the system</li> <li>7. Contact your pump professional</li> </ol>
The pump runs. There is flow but poor pressure	<ol style="list-style-type: none"> <li>1. Excessive flow demand</li> <li>2. Total head requirement too great for the pump</li> <li>3. Pump may be worn or damaged</li> <li>4. Air entering suction line reducing performance</li> </ol>	<ol style="list-style-type: none"> <li>1. Check that the pump selected is correct for the application</li> <li>2. Check the pump specification</li> <li>3. Contact your service agent</li> <li>4. Ensure the suction line is sealed correctly</li> </ol>
Pump cycling on and off	<ol style="list-style-type: none"> <li>1. Small water draw off or leak</li> <li>2. Leak in suction or discharge line</li> <li>3. Contamination in the controller</li> </ol>	<ol style="list-style-type: none"> <li>1. Check for small leaks i.e. taps or cistern</li> <li>2. Check for leaks including suction line non return valve</li> <li>3. Contact your service agent to inspect</li> </ol>
Pump runs intermittently	<ol style="list-style-type: none"> <li>1. Overheating and thermal protection tripping</li> </ol>	<ol style="list-style-type: none"> <li>1. Ensure the water temp is less than 40 deg C. Ensure sufficient airflow to cool the motor. <i>Note that low voltage can cause the motor to overheat.</i></li> </ol>
Pump vibrates and is noisy	<ol style="list-style-type: none"> <li>1. Incorrectly mounted/fixed</li> <li>2. Internal blockage causing impeller imbalance</li> <li>3. If the flow requirement is greater than the pump is capable of it will cavitate. <i>Cavitation sounds like gravel inside pump.</i></li> </ol>	<ol style="list-style-type: none"> <li>1. Ensure the pump is solidly attached to a base</li> <li>2. Contact your service agent</li> <li>3. Reduce the water demand to see if the noise disappears. Ensure the suction pipe is sized correctly. A different pump model may be required Contact your service agent</li> </ol>
Water leaking from the centre of the pump	<ol style="list-style-type: none"> <li>1. The mechanical seal is leaking</li> </ol>	<ol style="list-style-type: none"> <li>1. Contact your service agent for repair</li> </ol>





**[www.whiteint.com.au](http://www.whiteint.com.au)**

**[www.whiteint.co.nz](http://www.whiteint.co.nz)**

**Please always refer to our website for further technical information & new product innovations**

**Disclaimer:** Every effort has been made to publish the correct information in this manual.  
No responsibility will be taken for errors, omissions or changes in product specifications.

© 2024 Copyright White International Pty Ltd

TM ® - WARNING: Please be aware that various brands & products depicted within this document are subject to trademark, patent or design registrations. Infringement of any intellectual property contained within this document without express written authority by the appropriate intellectual property holder may result in further legal action to be taken. For any queries regarding use of the contained information please feel free to contact White International Pty Ltd.